

pleated blinds

measuring instructions

For accurate measurements please use a metal tape measure, and take measurements in centimetres, to the nearest 0.1cm.

- All of our blinds can be fixed into the face of the window frame or wall, or into the top of the lintel - allowing you total control of the depth your blind can be positioned in the depth of your window recess.
- Choose whether you want the blinds to hang inside or outside the window recess.
- Please check for the proximity of adjacent walls, furniture, window handles etc. when measuring for your blinds.

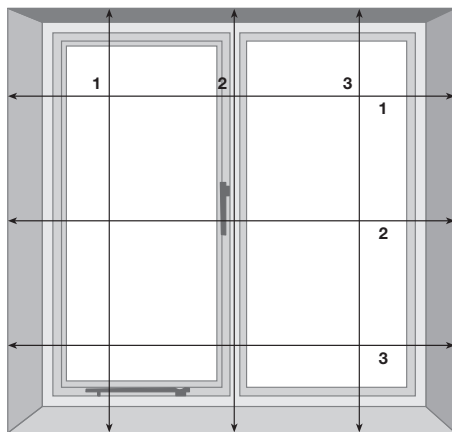

Recess

For blinds to hang inside the window recess:
Measure the drop by taking the measurement from the top of the recess to the window sill, in three places as shown. Measure the width of the window recess from wall to wall, in three places as shown. Take the smallest measurement. We will make all adjustments to ensure your blinds fit perfectly.

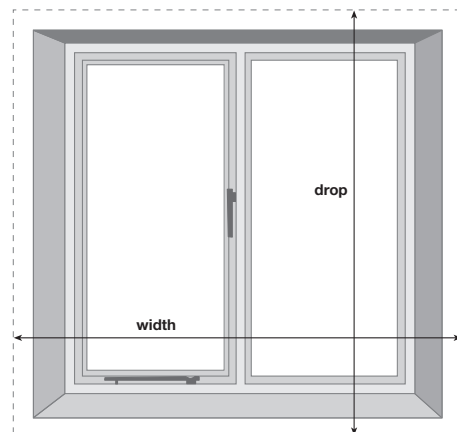

Exact

For blinds to hang outside the window recess:
Measure the exact area you would like the blind to cover as shown.

aftercare

Look after your blinds by following the straightforward operating instructions below.

Operating Instructions

- The cord on the Pleated blind operates the height of the blind.
- To release the cord lock, pull the cord forward then raise or lower the blind to achieve your desired effect. Re-lock the cord by pulling it towards the window.

Cleaning

- Pleated blinds simply need to be dusted using a dry duster. Be careful not to damage the pleats by pressing too hard.

Your local supplier:

NB: The manufacturer will not accept responsibility for damage to blinds caused by misuse. Fitting items may vary depending upon type of fitting requested.

pleated blinds

fitting instructions

fittings

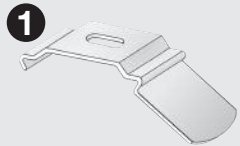

Top fix brackets:
min 2

2 Screws: min 4
Rawl plugs:
min 4

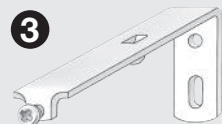
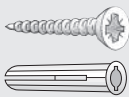

Face fix brackets
(with short screws):
min 2

4 Wood screws:
min 4

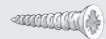

5 Blind: 1

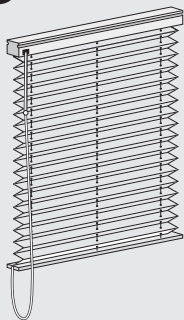

Outside Recess

If fitting the blind outside the window, measurements **(C)** will need to be the same. To work out **(C)**, simply minus **(B)** from **(A)** and divide the answer by two. Follow instructions for FACE FIXING

Inside recess

Decide whether to FACE or TOP FIX. FACE FIX to fit the bracket to the window frame. TOP FIX to the lintel if the window frame is uPVC, or if there are any obstructions, e.g. window handles.

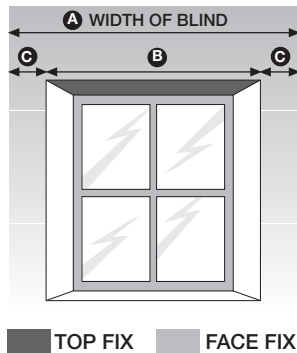

step one

Face Fixing

Lightly screw short screws into place. Position brackets approx 5cm from the ends of the headrail. Mark holes **A** and screw brackets into place.

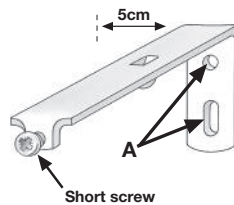

Top Fixing

Measure and mark the distance any handles protrude. Then, using the blind, find and mark the fitting position **A**. Drill brackets into position 5cm away from the side walls.

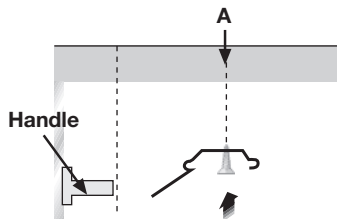

step two

Face Fixing

With cord lock towards you, hook **the back of the headrail into the brackets**. Tighten the short screws to lock the headrail into place.

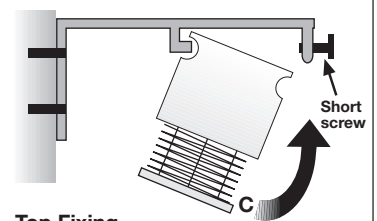

Top Fixing

Tilt and hook the front of the headrail (closest to you) into the bracket. Press the back up into position until it clicks. Push **B** up to release blind.

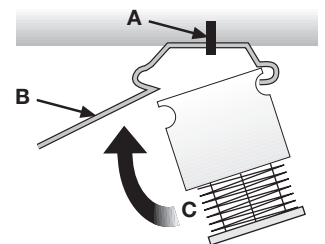

step three

Cord lock

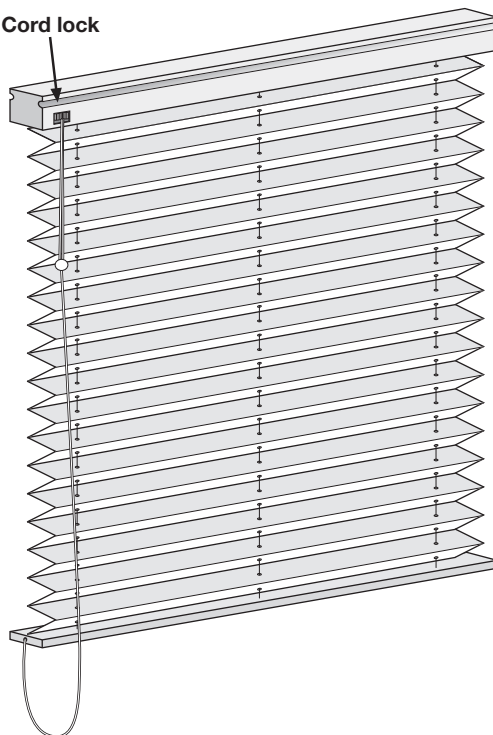

The pleats should now hang freely, with the cord lock positioned at the front of the blind.

step four

To raise and lower the blind use the cord at the side of the blind.

The cord lock will hold the blind at your desired height.

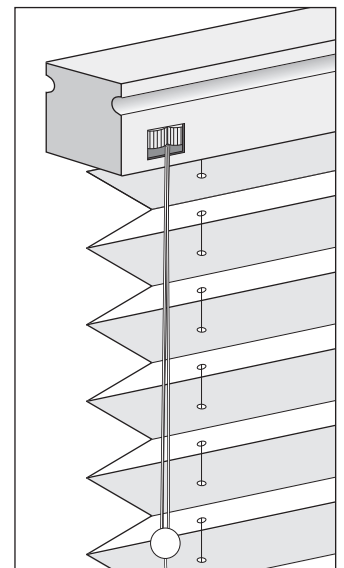

step five

WARNING

IN THE INTEREST OF SAFETY, IT IS ADVISABLE TO KEEP ALL PULL CORDS AND CHAIN/BEAD CORDS OUT OF THE REACH OF CHILDREN.